

# LTR-P Professional Series

## 1.5W, 12VDC and 24VDC LED Tape Specification Sheet



Project Name	Type
--------------	------

Catalog #	Date
-----------	------



### PRODUCT OVERVIEW

GM's Professional Series Flexible LED Tape combines style and technology with reliability. Designed for professional installations that demand a high level of quality, the LTR-P Series includes a wide array of key features and is available in 16'-4" (5M), 100' (30M) and 250' (76M) reels.

### FEATURES

- 12VDC or 24VDC models
- 2400K, 2700K, 3000K, 3500K, 4000K and 5000K color temps
- Dry location
- Remote control with GM's LUXcontrol™ App and controllers
- 120 LEDs per meter
- Cuttable every 2"
- Custom lengths available - consult factory
- Premium diodes
- 120° viewing angle
- Dimmable
- 3M adhesive back
- Maximum run on a given lead is 32'-8"(12V) and 60'(24V)
- Includes Sure-Tite connectors

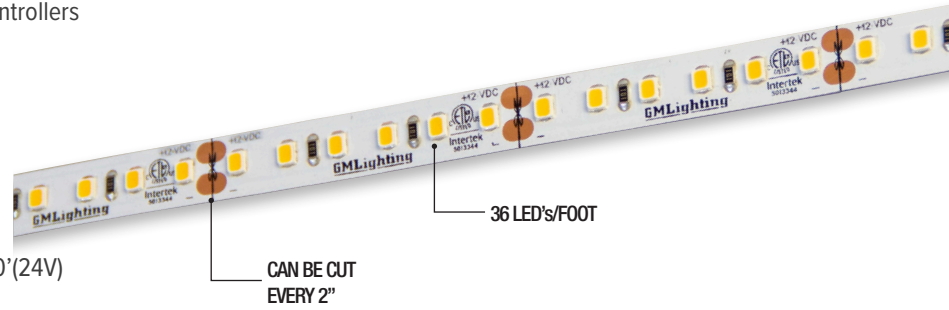

### SPECIFICATIONS

#### ELECTRICAL

- 12V/24V
- 1.5 watts per foot

#### OPTICS

- 90+ CRI

#### OPERATING TEMP

- -4 to 122 F

#### CERTIFICATION

- ETL (12V) / UL (24V)
- Title 24 compliant when used with used with specific drivers. Consult factory.
- Class 2
- Closet Rated: Complies with NEC code (NFPA70) 410.16, Suitable for installation within the clothes closet storage space

#### WARRANTY

- 5-year warranty when paired with GM power supply

### ORDERING INFORMATION

Example: LTR-P-12V-1.5W-24K-16

Model	Series	Voltage	Wattage	Color Temp	Reel Length
LTR	P	12V	1.5W	24K	16
				27K	
		24V		30K	100
				35K	
				40K	
50K	250				

\*Reel Length: 16 = 16'-4", 100 = 98'-6", 250 = 250'  
250ft. reels available in 27K, 30K and 35K only

### ACCESSORIES

Model	Description
ESTC-1	Sure-Tite tape to tape connector
ESTC-90	Sure-Tite 90° connector
ESTLK-60	Sure-Tite 60" adjustable tape to tape connector
ESTW-60	Sure-Tite 60" adjustable tape to power connector
ESTW-CO	Sure-Tite tape to power supply connector (no wire)

#### Your LED Tape Specification Checklist:

1. Select Tape
2. Select Connectors
3. Select Channels
4. Select Controllers or Dimmers
5. Select Power Supplies

Install Sheet



# LTR-P Professional Series

## 1.5W, 12VDC and 24VDC LED Tape Specification Sheet



Catalog No.	Length	Lumens	CRI	Color Temp.	Max. Run
LTR-P-12V-1.5W-24K-16	16'-4" / 5M	119	90+	2400K	32'-8"
LTR-P-12V-1.5W-27K-16	16'-4" / 5M	125	90+	2700K	32'-8"
LTR-P-12V-1.5W-30K-16	16'-4" / 5M	126	90+	3000K	32'-8"
LTR-P-12V-1.5W-35K-16	16'-4" / 5M	140	90+	3500K	32'-8"
LTR-P-12V-1.5W-40K-16	16'-4" / 5M	144	90+	4000K	32'-8"
LTR-P-12V-1.5W-50K-16	16'-4" / 5M	146	90+	5000K	32'-8"
LTR-P-12V-1.5W-24K-100	98'-6" / 30M	119	90+	2400K	32'-8"
LTR-P-12V-1.5W-27K-100	98'-6" / 30M	125	90+	2700K	32'-8"
LTR-P-12V-1.5W-30K-100	98'-6" / 30M	126	90+	3000K	32'-8"
LTR-P-12V-1.5W-35K-100	98'-6" / 30M	140	90+	3500K	32'-8"
LTR-P-12V-1.5W-40K-100	98'-6" / 30M	144	90+	4000K	32'-8"
LTR-P-12V-1.5W-50K-100	98'-6" / 30M	146	90+	5000K	32'-8"
LTR-P-12V-1.5W-27K-250	250' / 76M	125	90+	2700K	32'-8"
LTR-P-12V-1.5W-30K-250	250' / 76M	126	90+	3000K	32'-8"
LTR-P-12V-1.5W-35K-250	250' / 76M	140	90+	3500K	32'-8"
LTR-P-24V-1.5W-24K-16	16'-4" / 5M	119	90+	2400K	60'
LTR-P-24V-1.5W-27K-16	16'-4" / 5M	125	90+	2700K	60'
LTR-P-24V-1.5W-30K-16	16'-4" / 5M	126	90+	3000K	60'
LTR-P-24V-1.5W-35K-16	16'-4" / 5M	140	90+	3500K	60'
LTR-P-24V-1.5W-40K-16	16'-4" / 5M	144	90+	4000K	60'
LTR-P-24V-1.5W-50K-16	16'-4" / 5M	146	90+	5000K	60'
LTR-P-24V-1.5W-24K-100	98'-6" / 30M	119	90+	2400K	60'
LTR-P-24V-1.5W-27K-100	98'-6" / 30M	125	90+	2700K	60'
LTR-P-24V-1.5W-30K-100	98'-6" / 30M	126	90+	3000K	60'
LTR-P-24V-1.5W-35K-100	98'-6" / 30M	140	90+	3500K	60'
LTR-P-24V-1.5W-40K-100	98'-6" / 30M	144	90+	4000K	60'
LTR-P-24V-1.5W-50K-100	98'-6" / 30M	146	90+	5000K	60'
LTR-P-24V-1.5W-27K-250	250' / 76M	125	90+	2700K	60'
LTR-P-24V-1.5W-30K-250	250' / 76M	126	90+	3000K	60'
LTR-P-24V-1.5W-35K-250	250' / 76M	140	90+	3500K	60'

Kelvin temperature (color) ±100K.

16'-4" and 100' reel includes 48" lead affixed to tape. 16'-4" reel includes (3) ESTW-60 Sure-Tite connectors. 100' reel includes (10) ESTW-60 Sure-Tite connectors

### COMPATIBLE CONTROLLERS

Model	Description
SHWC	LUXcontrol Smart 2.4 GHz WiFi Controller, Standard 12V/24V Low Voltage, see page 8
SHWD	LUXcontrol Smart 2.4 GHz WiFi Dimmer, Standard 12V/24V Low Voltage, see page 8
SWD-40W-12VDC-DIM	SwitchLD All-in-One Dimmer and Driver, 40W, 12VDC see page 10
SWD-60W-12VDC-DIM	SwitchLD All-in-One Dimmer and Driver, 60W, 12VDC see page 10

# LTR-P Professional Series

## 1.5W, 12VDC and 24VDC LED Tape Specification Sheet



### RECOMMENDED DRIVERS

Catalog No.	Description	Watts	Specification Sheet
LD-ED-UNV	LineDrive Electronic Dimmable Power Supply, 12VDC or 24VDC	20W, 40W, 60W, 96W, 150W, 200W, 300W	<a href="#">View Spec Sheet</a>
LD-E-UNV	LineDrive Electronic Non-Dimmable Power Supply, 12VDC or 24VDC	30W, 60W, 96W, 200W, 300W	<a href="#">View Spec Sheet</a>
LD-MD-UNV	LineDrive Magnetic Dimmable Power Supply, 12VDC or 24VDC	30W, 60W, 96W, 150W, 200W, 300W	<a href="#">View Spec Sheet</a>
LD-EDM	LineDrive Electronic Dimmable MINI Power Supply, 12VDC or 24VDC	60W	<a href="#">View Spec Sheet</a>
LD-ED010	LineDrive Electronic Dimmable 0-10V Power Supply, 12VDC or 24VDC	60W, 96W	<a href="#">View Spec Sheet</a>
LTP	Cord and Plug Power Supply, 12VDC or 24VDC	25W, 48W, 60W, 90W	<a href="#">View Spec Sheet</a>
PSD	Electronic Dimmable Power Supply, 12VDC or 24VDC	15W, 24W, 60W, 90W	<a href="#">View Spec Sheet</a>

Please see our website for updated power supply specifications and information.

### DIMENSION

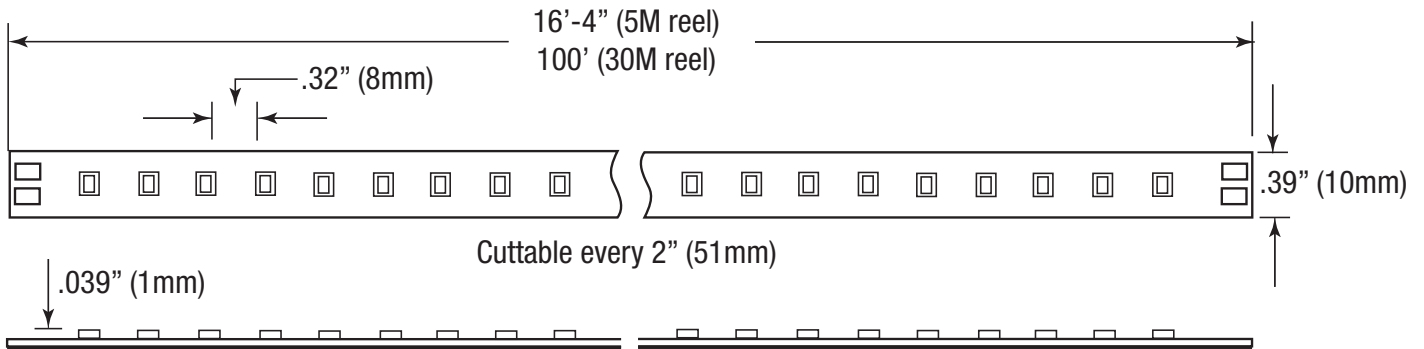

### EST SERIES CONNECTORS

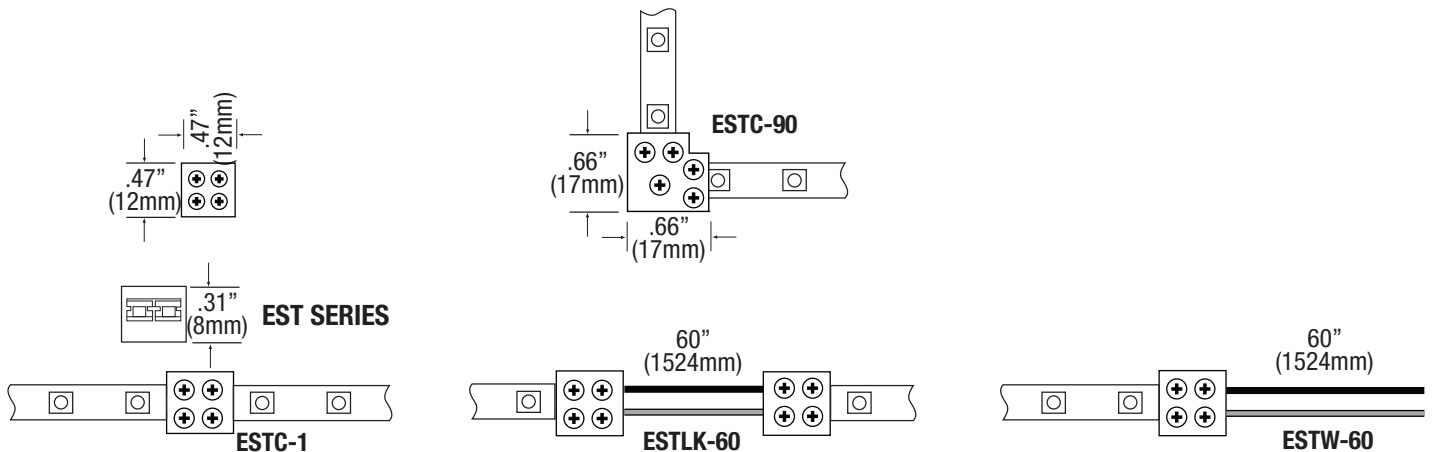

# LTR-P Professional Series

## 1.5W, 12VDC and 24VDC LED Tape Specification Sheet



### COMPATIBLE CHANNELS - FIT CONNECTORS ON PG. 1

#### EXTRA DEEP

Catalog No.	Description	Length	Dimensions
LED-CHL-XD	Extra deep format extruded channel. Includes snap-on frosted lens with mounting clips and screws.	4'	
LED-CHL-XD-8	Extra deep format extruded channel. Includes snap-on frosted lens with mounting clips and screws.	8'	
LED-CHL-XD-AMC	(2) Adjustable mounting brackets for LED-CHL-XD	N/A	
LED-CHL-XD-EC	(2) End caps for LED-CHL-XD. One solid, one with hole.	N/A	
LED-CHL-XD-MC	(2) Mounting clips and screws for LED-CHL-XD	N/A	

#### EXTRA DEEP FLANGED

LED-CHL-XD-F	Extra deep format extruded channel with flange. Includes snap-on frosted lens with mounting clips and screws.	4'	
LED-CHL-XD-F-8	Extra deep format extruded channel with flange. Includes snap-on frosted lens with mounting clips and screws.	8'	
LED-CHL-XD-F-DC	(2) Drywall mounting brackets for LED-CHL-XD-F	N/A	
LED-CHL-XD-F-EC	(2) End caps for LED-CHL-XD-F. One solid, one with hole.	N/A	

#### MINI DEEP

LED-CHL-XD-MD	Mini deep format extruded channel. Includes snap-on frosted lens with mounting clips and screws.	4'	
LED-CHL-XD-MD-WH	Mini deep format extruded channel. Includes snap-on frosted lens with mounting clips and screws. White.	4'	
LED-CHL-XD-MD-B	Mini deep format extruded channel. Includes snap-on frosted lens with mounting clips and screws. Black.	4'	
LED-CHL-XD-MD-8	Mini deep format extruded channel with flange. Includes snap-on frosted lens with mounting clips and screws.	8'	
LED-CHL-XD-MD-8-WH	Mini deep format extruded channel. Includes snap-on frosted lens with mounting clips and screws. White.	8'	
LED-CHL-XD-MD-8-B	Mini deep format extruded channel. Includes snap-on frosted lens with mounting clips and screws. Black.	8'	
LED-CHL-XD-MD-AMC	(2) Adjustable mounting brackets for LED-CHL-XD-MD	N/A	
LED-CHL-XD-MD-EC	(2) End caps for LED-CHL-XD-MD. One solid, one with hole.	N/A	
LED-CHL-XD-MD-MC	(2) Mounting clips for LED-CHL-XD-MD	N/A	

#### MINI DEEP FLANGED

LED-CHL-XD-MD-F	Mini deep format flanged extruded channel with flange. Includes snap-on frosted lens with mounting clips and screws.	4'	
LED-CHL-XD-MD-F-WH	Mini deep format flanged extruded channel with flange. Includes snap-on frosted lens with mounting clips and screws. White.	4'	
LED-CHL-XD-MD-F-B	Mini deep format flanged extruded channel with flange. Includes snap-on frosted lens with mounting clips and screws. Black.	4'	
LED-CHL-XD-MD-F-8	Mini deep format extruded flanged channel with flange. Includes snap-on frosted lens with mounting clips and screws.	8'	
LED-CHL-XD-MD-F-8-WH	Mini deep format extruded flanged channel with flange. Includes snap-on frosted lens with mounting clips and screws. White.	8'	
LED-CHL-XD-MD-F-8-B	Mini deep format extruded flanged channel with flange. Includes snap-on frosted lens with mounting clips and screws. Black.	8'	
LED-CHL-XD-MD-F-DC	(2) Drywall mounting brackets for LED-CHL-XD-MD-F	N/A	
LED-CHL-XD-MD-F-EC	(2) End caps for LED-CHL-XD-MD-F. One solid, one with hole.	N/A	

# LTR-P Professional Series

## 1.5W, 12VDC and 24VDC LED Tape Specification Sheet



### COMPATIBLE CHANNELS- FIT CONNECTORS ON PG. 1

#### 45° ANGLE MOUNT

Catalog No.	Description	Dimensions
LED-CHL-45	Extruded angled (45°) channel. Includes snap-on frosted lens with mounting clips and screws.	4'
LED-CHL-45-EC	(2) End caps for LED-CHL-45 - one solid, one with hole	N/A
LED-CHL-45-MC	(2) Mounting clips and screws for LED-CHL-45	N/A

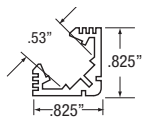

#### 45° LARGE ANGLE MOUNT

LED-CHL-45-1200	Extruded angled (45°) channel. Includes snap-on frosted lens with mounting clips and screws.	4'
LED-CHL-45-1200-EC	(2) End caps for LED-CHL-45 - one solid, one with hole	N/A
LED-CHL-45-1200-MC	(2) Additional mounting clips for LED-CHL-45-1200	N/A

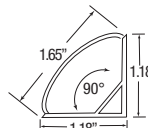

#### WIDE

LED-CHL-W	Wide format extruded channel. Includes snap-on frosted lens with mounting clips and screws.	4'
LED-CHL-W-8	Wide format extruded channel. Includes snap-on frosted lens with mounting clips and screws.	8'
LED-CHL-W-AMC	(2) Adjustable mounting brackets for LED-CHL-W	N/A
LED-CHL-W-EC	(2) End caps for LED-CHL-W - one solid, one with hole.	N/A
LED-CHL-W-MC	(2) Additional mounting clips for LED-CHL-W	N/A

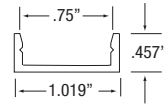

#### MUD IN - STANDARD

Catalog No.	Description	Dimensions
LED-CHL-MI-ST8	8ft. Standard extruded aluminum mud-in channel. Includes snap-on frosted lens.	8'
LED-CHL-MI-ST-EC	(2) End caps for LED-CHL-MI-ST8 one solid, one with hole.	N/A

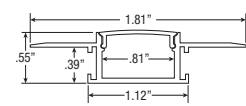

### COMPATIBLE CHANNELS - SOLDERED LEADS ONLY

#### STANDARD STRAIGHT

Catalog No.	Description	Dimensions
LED-CHL	Extruded channel. Includes snap-on frosted lens with mounting clips and screws.	4'
LED-CHL-8	Extruded channel. Includes snap-on frosted lens with mounting clips and screws.	8'
LED-CHL-AMC	(2) Adjustable mounting brackets for LED-CHL	N/A
LED-CHL-EC	(2) End caps for LED-CHL - one solid, one with hole.	N/A
LED-CHL-MC	(2) Additional mounting clips for LED-CHL	N/A

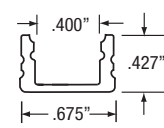

# LTR-P Professional Series

## 1.5W, 12VDC and 24VDC LED Tape Specification Sheet



### SHWC LUXCONTROL WIFI CONTROLLER

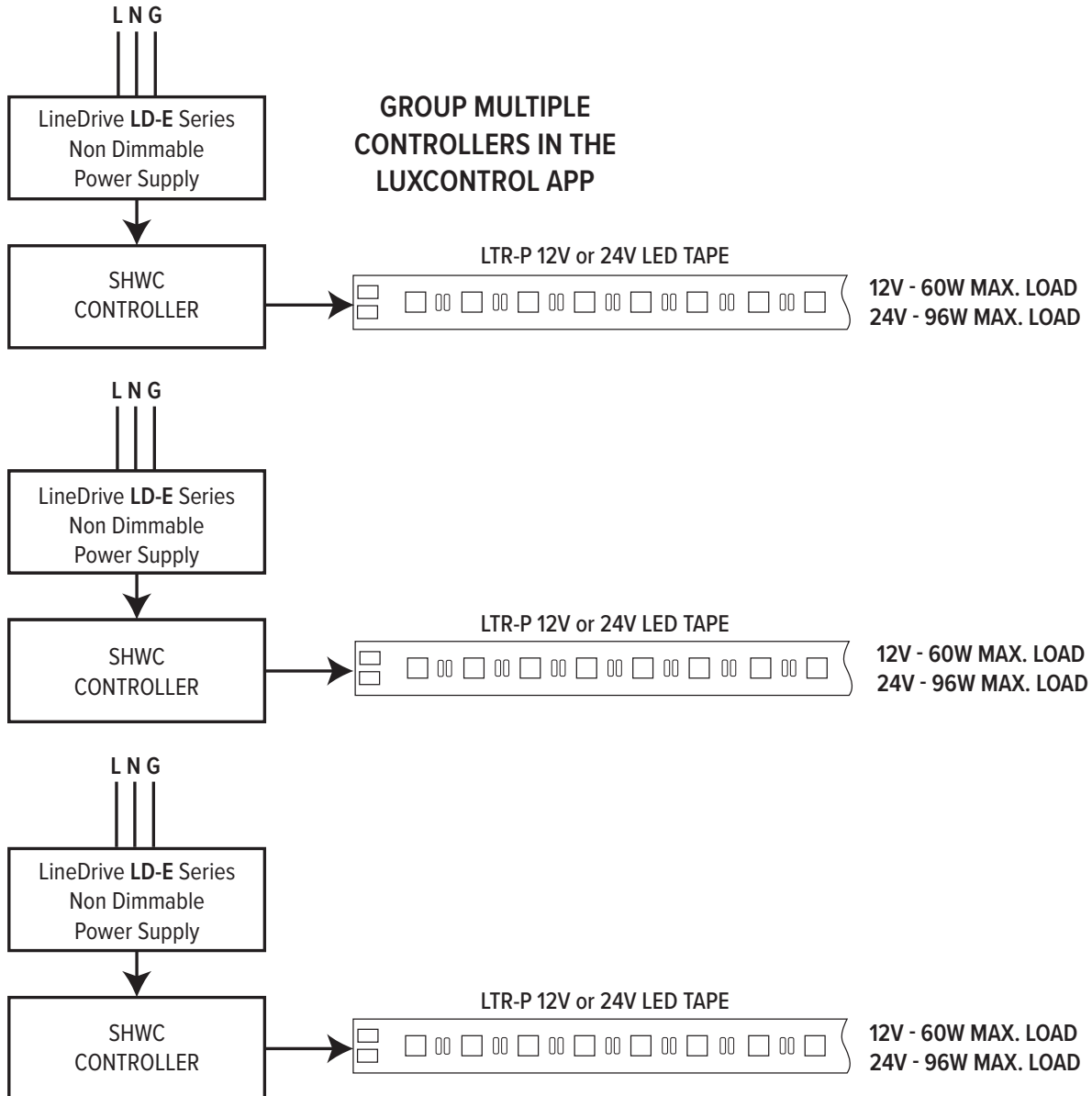

# LTR-P Professional Series

## 1.5W, 12VDC and 24VDC LED Tape Specification Sheet



### SHWC LUXCONTROL WIFI CONTROLLER WITH POWER REPEATER

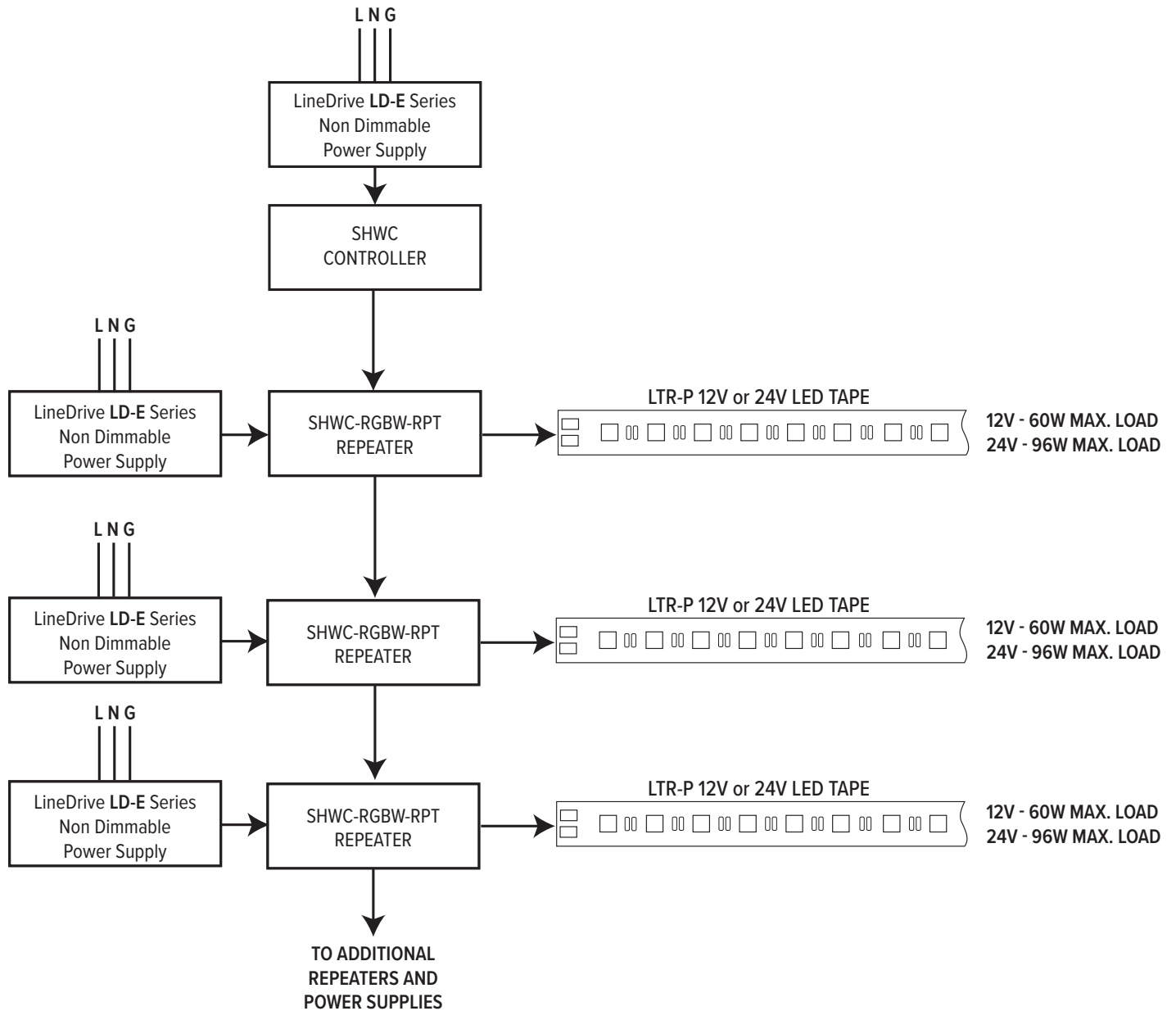

# LTR-P Professional Series

## 1.5W, 12VDC and 24VDC LED Tape Specification Sheet



### SHWD LUXCONTROL WIFI DIMMER

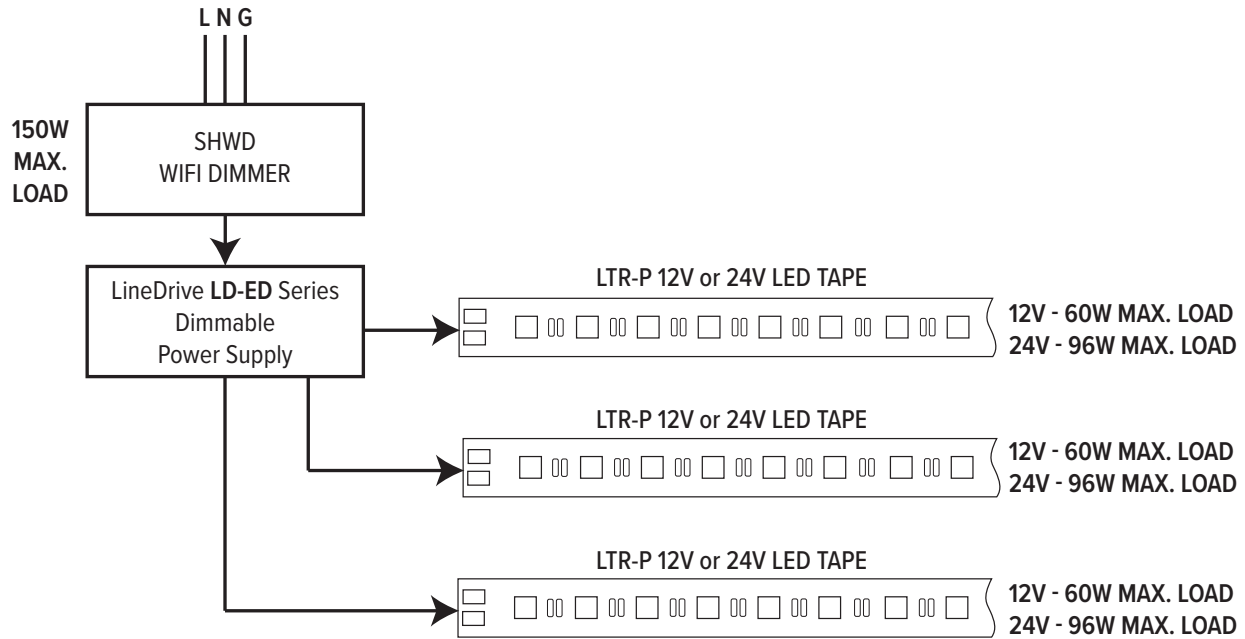

### SWITCHLD SWD DRIVER AND DIMMER

