

# Lamina RGBW

## 24VDC Configural Laminated Sheet



Project Name	Type
Catalog #	Date

### PRODUCT OVERVIEW

Lamina RGBW is a 24VDC flexible light sheet that can be cut in the field into geometric or irregular shapes, creating limitless illumination for signage, light panels, retail display, back lighting and themed lighting applications. Easy installation with no heat sink required. Standard 12" x 12" sheets make it easy to plan your layout and install (see next page).



### FEATURES

- RGBW (with 3000K white light)
- 90+ CRI
- Dimmable
- Connectible via integral push-in connectors
- 3M Double-sided tape for mounting
- 3M tape, staple or screw mounting options
- For indoor use only
- Tight diode to diode spacing for even illumination and no hot spots
- New convenient size 12x12in = 1 Sq. Ft
- Invisible Stand-Off support option allows even illumination with translucent panels (easily raises diffusion translucent panels 0.91" - 2.0" above Lamina. For horizontal surface use only).
- Not intended for outdoor use
- Operating temp. -4°F - 122°F\*

**EVEN RGBW ILLUMINATION FIELD CUT VERSATILITY**

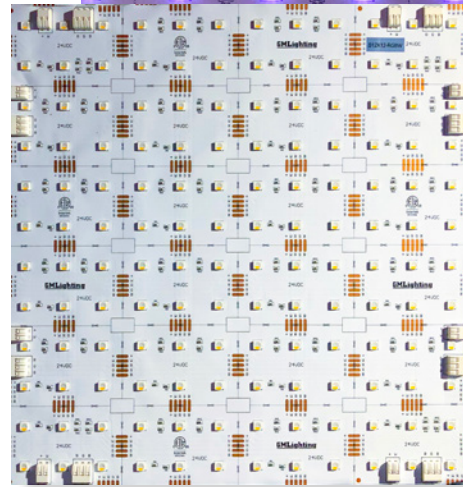

Sheets can be rotated to get cut lines into the best orientation for the application. Align all sheets the same way.

### SPECIFICATIONS

#### ELECTRICAL

- 11.5W / Sq.Ft.
- 24VDC
- PCB zones

#### LABEL

- ETL
- IP20

#### OPTICS

- 5050 RGBW SMD
- 144 LEDs with 1" spacing
- 90+ CRI
- 3000K white light (420lm)

#### WARRANTY

- 5-years

### ORDERING INFORMATION

Example: S12X12-RGBW

Series	-	Color Temp.
S12X12-RGBW	-	RGBW (3000K WHITE CHANNEL)

### CONNECTORS

Catalog No.	Description
S12X12-RGBW-SSC	Sheet to Sheet Wire Connector

### Your Lamina Specification Checklist:

1. Select Sheets
2. Select Connectors
3. Select Channels
4. Select Controllers
5. Select Power Supplies

### INSTALL SHEET



SCAN ME

Catalog No.	Output	Dimension	Wattage	Lumens	CRI
S12X12	RGBW	12" x 12"	11.5W / Sq. Ft.	420lm White Light	90+ (White Only)

### STAND-OFF ACCESSORIES

Model	Description	Diameter	Height Range	Max. Load	Recommended Screw Size (not included)
GM-SOC-1	Clear, Acrylic w/clear 3M tape	13mm (0.62")	23mm (0.91") to 33mm (1.30")	6 lbs.	#6 x 3/4" Pan Head Sheet Metal Screw
GM-SOC-1	Clear, Acrylic w/clear 3M tape	19mm (0.75")	36mm (1.42") to 51mm (2.00")	10 lbs.	#8 x 3/4" Pan Head Sheet Metal Screw

Note: Stand-offs come in sets of 4

### COMPATIBLE CONTROLLERS

Model	Description
SHWC-RGBW	LUXcontrol Smart 2.4 GHz WiFi Controller, Standard 12V/24V Low Voltage, RGBW, 4-Channel / 5-Wire, see page 8
SHWC-RGBW-RPT	LUXcontrol Universal Smart Power Repeater, see page 9
RGBW-RWC	RGBW controller/amp with battery-powered remote, see page 5
RGBW-RP	RGBW repeater, see page 6
DMX-LT-995	5-Channel DMX Decoder, see page 10
RGBW-DMX-WC	DMX Wall ConAtrroller, see page 10

### RECOMMENDED DRIVERS

Catalog No.	Description	Watts	Weight	Dimensions
LD-E-UNV30	12VDC / 24VDC - 30W - 120V or 277V - 50/60Hz 12V/2.5A - 24V/1.25A - Class 2 Auto reset.	30W	1.0 lbs.	6.10"L x 3.35"W x 1.33"H
LD-E-UNV60	12VDC / 24VDC - 60W - 120V or 277V - 50/60Hz 12V/5A - 24V/2.5A - Class 2 Auto reset.	60W	2.5 lbs.	8.25"L x 4.10"W x 1.56"H
LD-E-UNV96-24	24VDC - 96W - 120V or 277V - 50/60Hz - 4 amps Class 2 - Auto reset.	96W	2.5 lbs.	8.25"L x 4.10"W x 1.56"H
LD-E-UNV200-24	24VDC - 192W - 120V or 277V - 50/60Hz - 4 amps per channel (2) Class 2 - Auto reset. 2 X 96W channel.	192W	4.7 lbs.	9.50"L x 6.35"W x 1.56"H
LD-E-UNV300-24	24VDC - 288W - 120V or 277V - 50/60Hz - 4 amps per channel (3) Class 2 - Auto reset. 3 X 96W channel.	288W	4.7 lbs.	9.50"L x 6.35"W x 1.56"H

Please see our website for updated power supply specifications and information.

### CORD & PLUG DRIVERS

Catalog No.	Description	Watts	Weight	Dimensions
LTP24-48	24VDC - 48W - 2 amps - 120V - 120V Cord (72") and plug. Short circuit, overload protection - LED indicator for power on. UL listed	48W	1.8 lbs.	4.68"L x 2.05"W x 1.25"H
LTP24-90	24VDC - 90W - 3.75 amps - 120V - 120V Cord (72") and plug. Short circuit, overload protection - LED indicator for power on. UL listed	90W	1.8 lbs.	4.68"L x 2.05"W x 1.25"H

Please see our website for updated power supply specifications and information.

### LAMINA DIAGRAM

**Installation:**  
Attach stand-off to Lamina board on center with rectangles. Use adhesive disc or #6 screw (by others). Space out as needed to distribute weight of translucent sheet evenly.

**CAUTION:**  
Stand-offs are to be used on top of horizontal surfaces only. Not for vertical wall or ceiling applications.

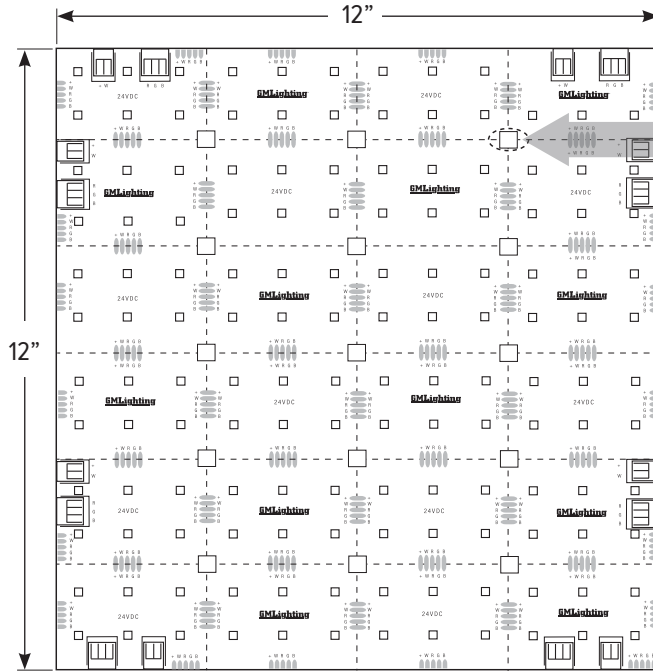

### Stand-Off Application

Translucent Sheet  
Adjust height by rotating top  
Option to apply adhesive disc here to bottom

Minimum radius of one-directional bends is 6". Using a tighter bend will damage product

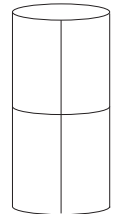

Create light pillars, illuminated table columns or whatever your imagination can conjure up!

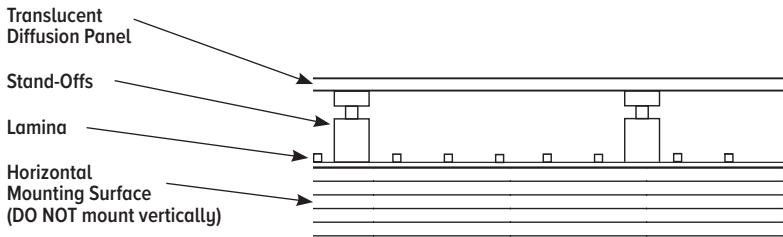

2" Cut Lines (shown in vertical format direction)

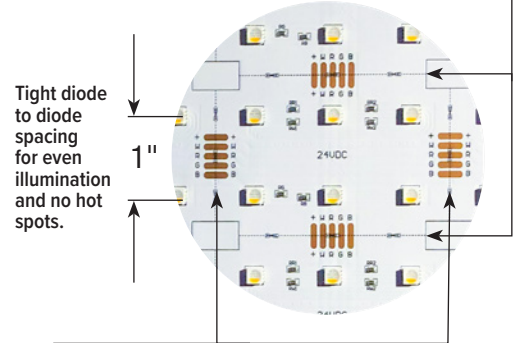

Tight diode to diode spacing for even illumination and no hot spots.

3" Cut Lines (shown in horizontal format direction)

**NOTE:** Even illumination will vary depending on materials, please verify offset for even illumination.

### MULTIPLE PANEL CONNECTION DIAGRAM

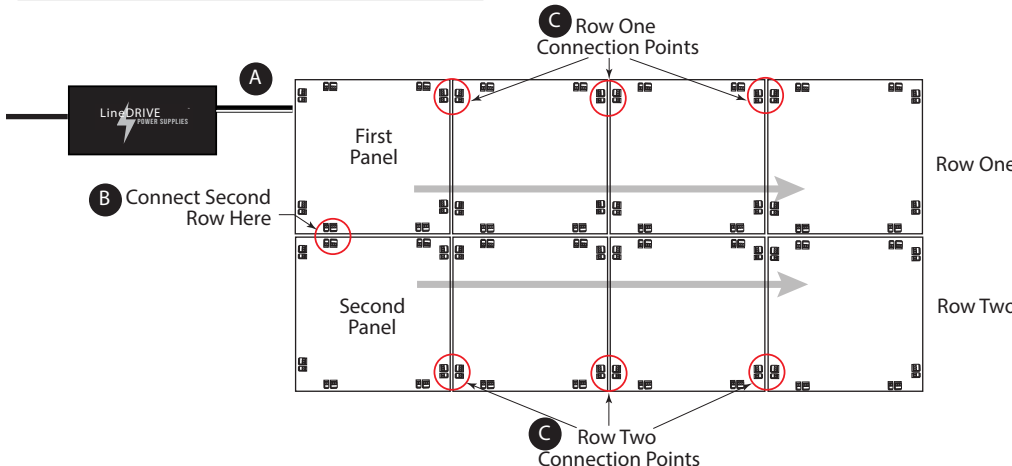

### Layout & Wiring Tips (See example):

- A.** Connect power to First Panel (1) in group.
- B.** Connect panel in Row Two, making connection between bottom of First Panel and top of First Panel in Row Two.
- C.** Connect additional panels in each row as you see in the diagram. Remaining panels are connected in one direction only.

**Many other layouts can be created for different shapes depending on panel cuts and position.**

# Lamina RGBW

## 24VDC Configural Laminated Sheet



### RGBW-RWC HAND-HELD REMOTE CONTROLLER

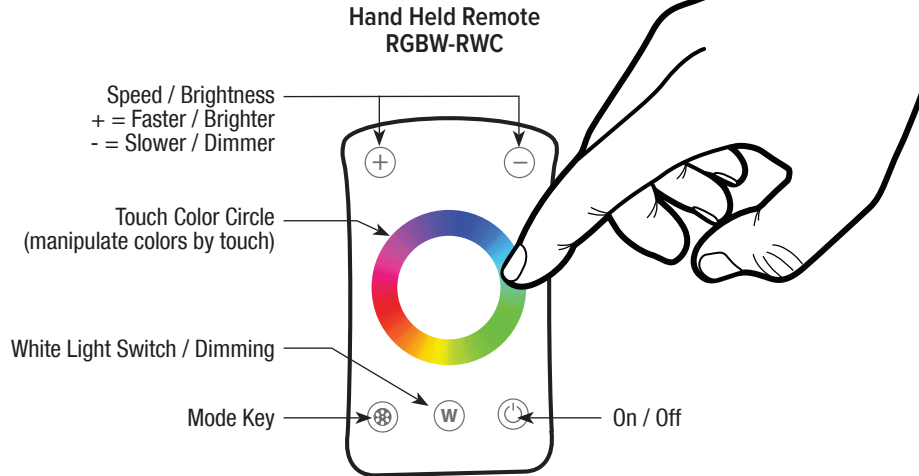

No.	Mode	Instruction
1	Static Red	Brightness Adjustable
2	Static Green	Brightness Adjustable
3	Static Blue	Brightness Adjustable
4	Static Yellow	Brightness Adjustable
5	Static Purple	Brightness Adjustable
6	Static Cyan	Brightness Adjustable

No.	Mode	Instruction
7	Static White	Brightness Adjustable
8	RGB Skipping	Speed/ Brightness Adjustable
9	7 Color Skipping	Speed/ Brightness Adjustable
10	RGB Color Smooth	Speed/ Brightness Adjustable
11	Full Color Smooth	Speed/ Brightness Adjustable
12	Static Black	White light can be turn off and adjusted

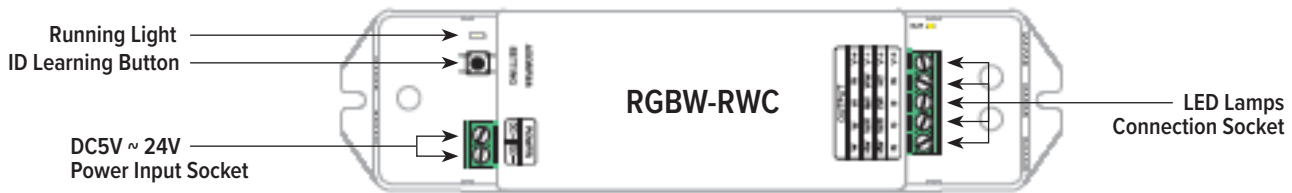

### RGBW-RWC HAND-HELD REMOTE CONTROLLER WIRING DIAGRAM

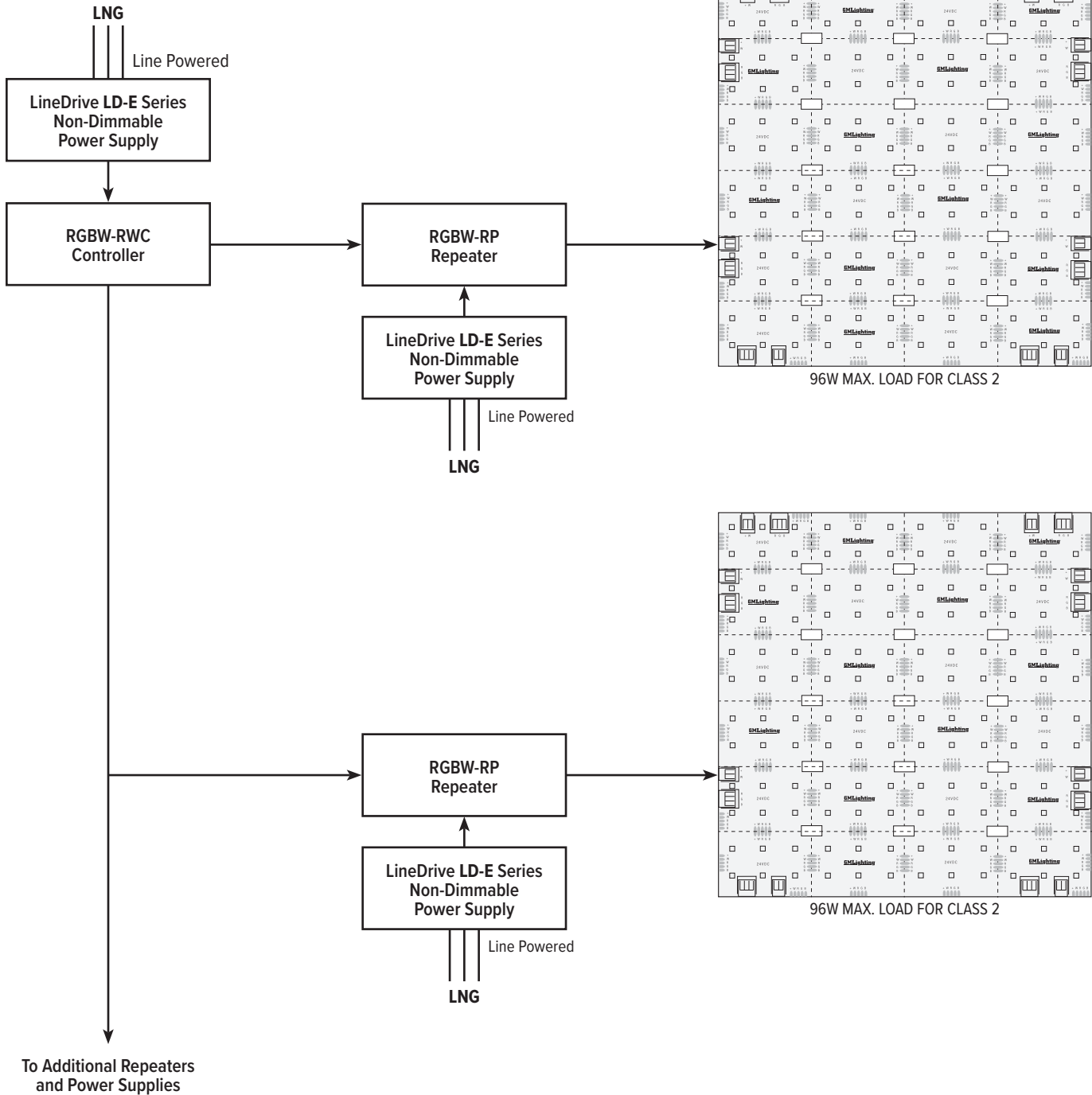

# Lamina RGBW

## 24VDC Configural Laminated Sheet



### SHWC-RGBW LUXCONTROL WIFI CONTROLLER

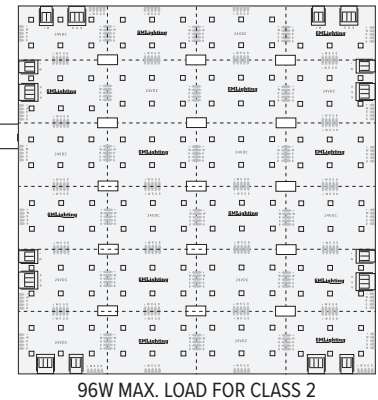
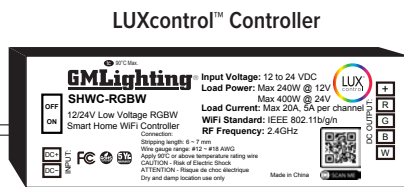
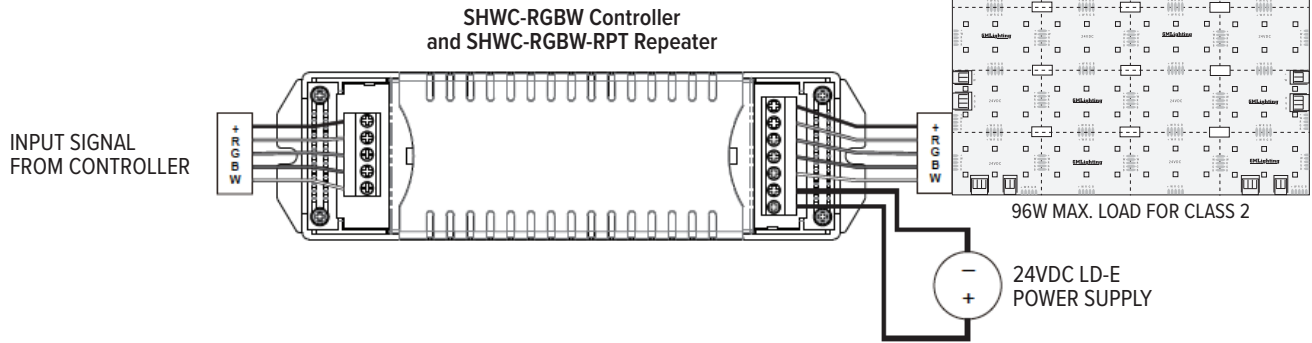
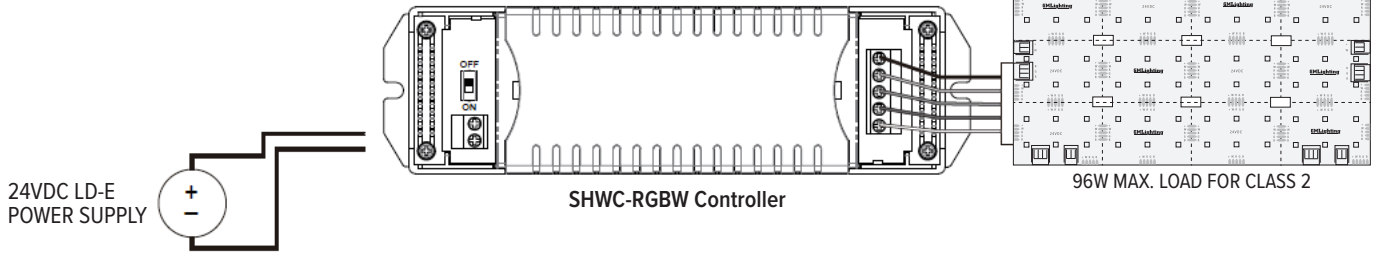

Expandable with universal power repeater (SHWC-RGBW-RPT) for larger projects

Note: For use with LD-E (non-dimmable) or LD-ED (dimmable) power supply only. Not compatible with LD-MD (magnetic) power supply.



### SHWC-RGBW LUXCONTROL WIFI CONTROLLER WIRING DIAGRAM

#### GROUP MULTIPLE CONTROLLERS IN THE LUXCONTROL APP

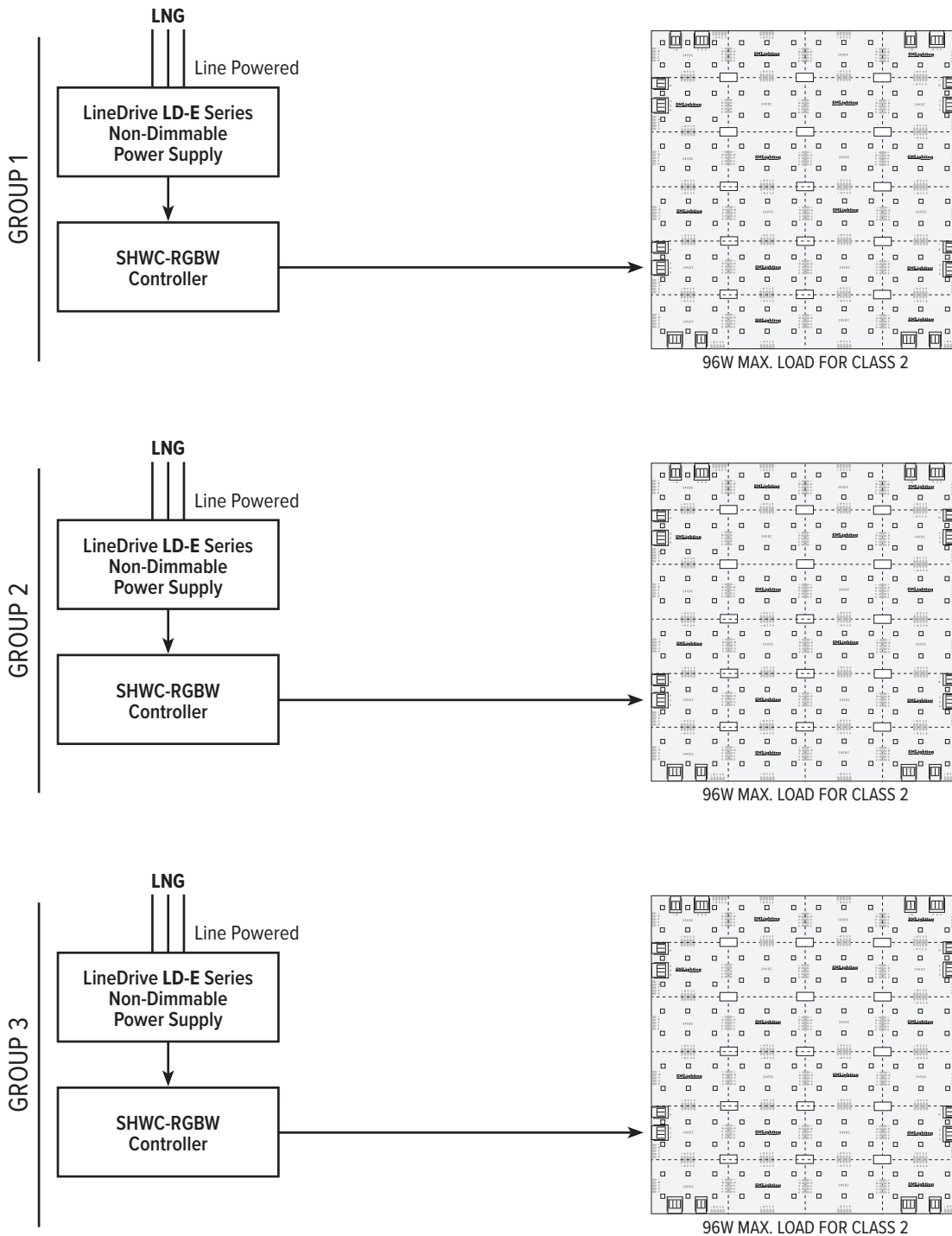

### SHWC-RGBW LUXCONTROL WIFI CONTROLLER WITH POWER REPEATER WIRING DIAGRAM

**THIS CONFIGURATION WILL  
SHOW UP AS ONE GROUP IN  
THE LUXCONTROL APP**

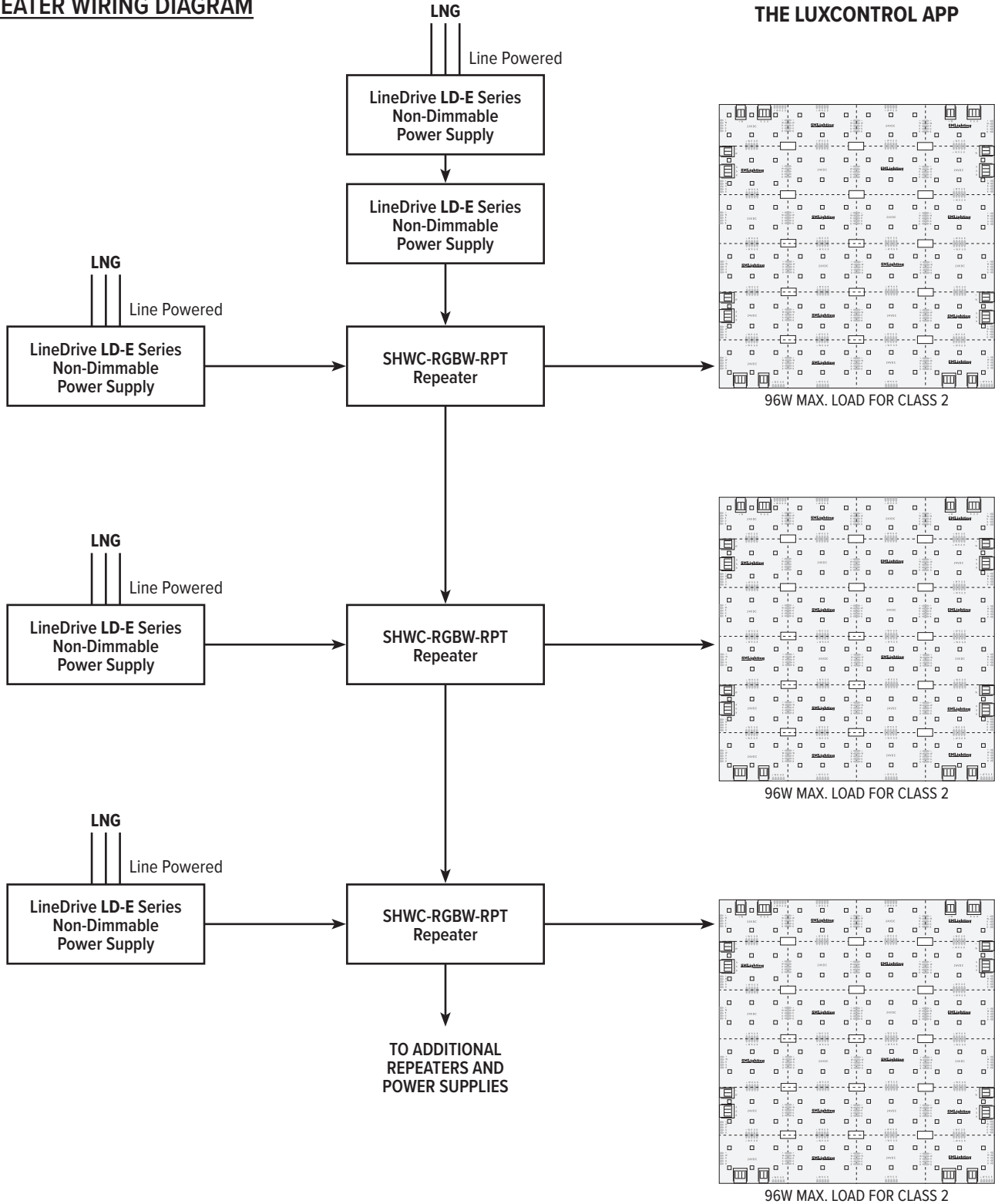



### RGBW-DMX-WC DMX WALL CONTROLLER WIRING DIAGRAM

